

MLC-ENC-RM



Documentation

MLC-32I, MLC-16R, MLC-8IC, ENC-RM I/O Systems Rack Hardware Installation Guide

Notice

Installation of this product must be in accordance with all safety codes. It is recommended prior to installation the installer consult with and get approval of local fire officials before installing locks or devices on any doors that may be fire exits. The use of egress push buttons may not be legal. Single action exit may be required. The installer should always obtain proper permits and approvals in writing before installing equipment.

Installation of this product shall be in accordance with all Local, State, and Federal Laws. The installer is responsible to insure the product is installed according to the rules and guidelines of the National Electrical Code as well as State or Local Codes.

The information in this document is subject to change without notice.

It is recommended the installer read and understand the complete installation manual prior to installation of this product.

Table of Contents

Chapter 1: The ENC-RM Rack	6
ENC-RM Rack Design and Layout with I/O Cards Installed	7
Installation Considerations	7
ENC-RM Rack Design and Layout	8
Wire Terminations	9
Network Cable Guidelines	9
Chapter 2: Wiring Topologies	10
MASC Configuration Options	10
Free Topology Star	11
Free Topology Loop	12
Bus Topology	13
Doubly Terminated Bus Topology	13
Singly Terminated Bus Topology	13
Bus Topology, Specific Rules	14
SLTA-10 Settings	15
Chapter 3: Connections	17
Connecting Power	17
Panel Grounding	18
System Battery	18
Panel Tamper Switch	18
RAM Battery	18
Relay Outputs	18
MLC-32i-RM Input Card	19
Input Status Monitoring Card	20
MLC16R-RM Output Card	21
MLC-8IC Intercom Card	22
MLC-8IC Intercom Design Layout	23
MPU-24 Communications Processor Board	24
Chapter 4: Panel Guidelines and Information	25
MLC32i-RM Input Rack Mounting Card Specification	25
MLC16R-RM Relay Output Rack Mounting Card Specification	26
MLC-8IC Intercom Rack Mounting Card Specification	27
MPU-24 Application and Communications Processor Specification	28
Chapter 6: Troubleshooting Guides	29
Chapter 6: Quick Start Guides	33
Installing and Configuring the MASC Server Software	33
Installing MAC-4R Drivers	33
Installing the Driver for the Echelon LT-USB Adapter	34
Installing the Hardware Driver for the iLon-10 (LT-EA-10) Adapter	34
Adding a MAC-4R Driver	35
Adding Control Panels	36
Turn Driver On-Line	36
Set the Address of the Controller	36

ENC-RM Rack Design and Layout with I/O Cards Installed

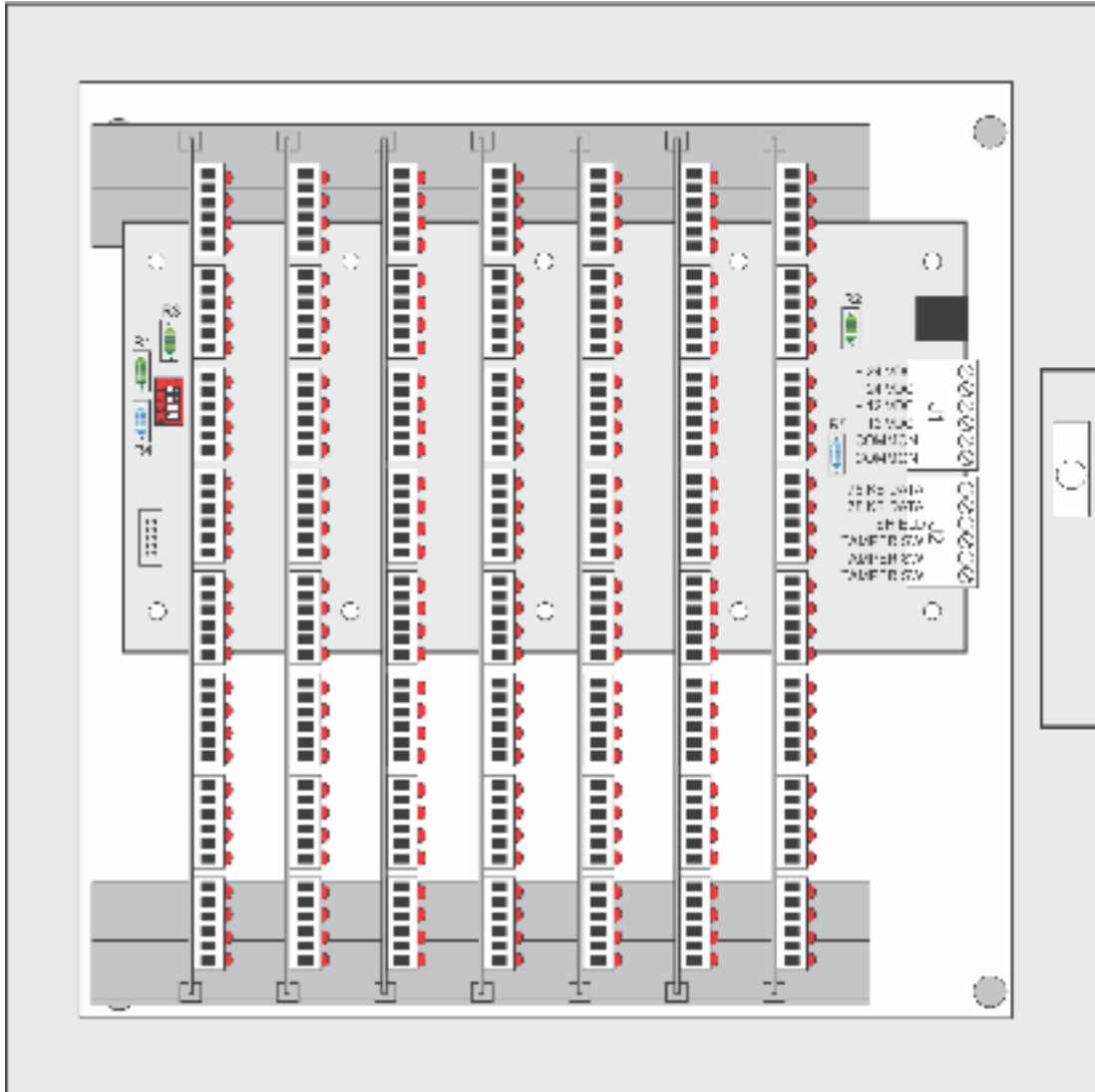

The MASC Logic Series Controllers consists of the following: MLC-32I, MLC-16R, and MLC-8IC Intelligent Controllers, ENC-RM Rack Mount Enclosure and PWR-RM power supply. Each MLC controller uses distributed processing and operates independent from any other controller. Power, Ground, and Communication Distribution is achieved by placing the MLC controller into the ENC-RM enclosure. The BP-7 back plane is the part number for the PCB board mounted in the ENC-RM enclosure.

The MASC Logic Controller's (MLC) use 12 VDC power supply with battery backup and battery charging circuit. The PWR-RM provides a 6.5 amp 12 VDC power supply in a lockable 12"W x 13"H x 5"D enclosure. Battery connection wiring is supplied but batteries are ordered separately.

The MLC-32I Controller supports up to 32 Inputs individually configured as 2-State, 3-State, 3-State EOL, 4-State, or analog. Drag-n-drop ladder logic is used to configure the inputs with Time zones, General points, and Alarm points.

The MLC-16R Controller supports up to 16 PLC based programmable relays. Each relay is rated for 6 amps @ 300 volts with Form C Single Pole, Single Throw contacts. The relays have their common pole individually fused at 5 amps @ 125 volts, 2AG Type user replaceable fuse. PCB board rated at 120 Volts, electrically isolated from other circuits.

The MLC-8IC Controller supports up to 8 PLC based intercom stations to a common talk path. Each station has one input and one Output. Inputs can be configured as Normally Open or Normally closed. The audio outputs are rated at 60 Watts.

Each of the MLC Controllers communicate to the host computer using the Free Topology 78kb Echelon Communications transceivers. A Host converter is required at the main computer. Supported computer ports include RS232, USB or Ethernet.

INSTALLATION CONSIDERATIONS:

1. MINIMUM SYSTEM CONFIGURATION:

- a. One MLC-Series Intelligent Controller.
- b. One ENC-RM Rack
- c. One PWR-RM Power supply
- d. One Echelon Network interface, LT-SA-10, LT-USB, LT-EA-10
- e. One MASC server package: Server 1, 2, or 3

2. The MLC-Series System is intended to be installed in accordance with the Manufacturer's Installation Instructions and the following:

- a. The National Electrical Code, NFPA 70.

3. The MLC-Series Intelligent Controllers are only intended for use with a UL Listed Class II 12 VDC power supply rated at 4-6.5 amps.

ENC-RM Rack Design and Layout

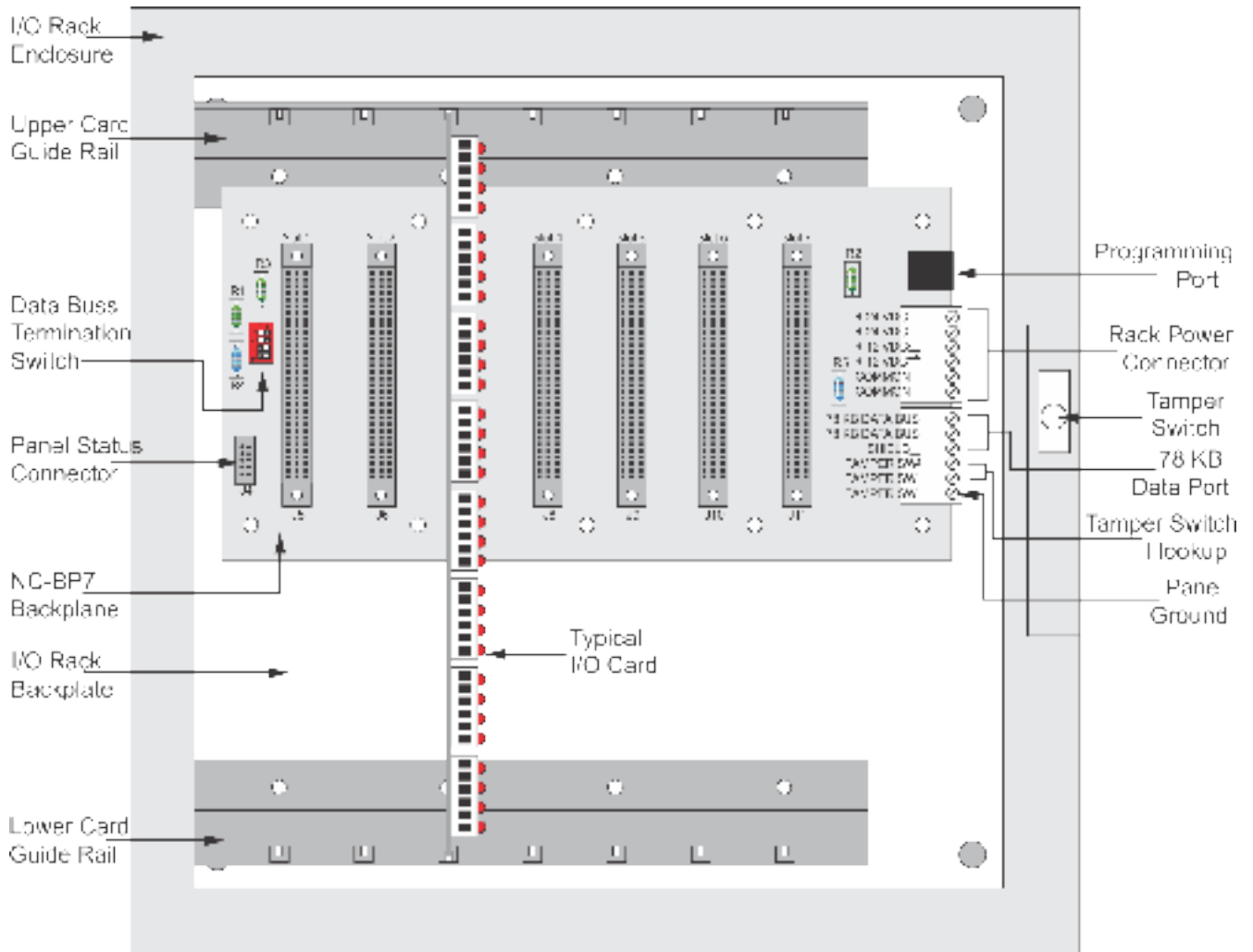

Typically, the rack is mounted in a 16" x 16" x 7" enclosure supplied with the rack upon order. The rack may be removed and mounted in a network rack or larger enclosure with other equipment.

Wire Terminations

All terminations are via plug-in connectors. All field wire connectors are screw-terminal compression type, accepting up to #14AWG solid or stranded wire. Stranded-type wire is recommended. If solid-type wire is to be used, it is recommended that wire be no larger than #18AWG. Strip approximately ¼” of the insulation from lead wires for insertion into the connector terminal plugs. Screw terminals clamp down onto the wires by advancing the screws in a clockwise direction. It may be necessary to loosen each of the screws prior to panel wiring to allow ease of wire insertion. It is recommended when tightening screws to remove the plug connector from its socket. Excessive pressure while tightening may damage the PC Board. Use care when tightening screws with plug connector inserted.

Network Cable Guidelines

The MLC Controllers use Echelon’s LonTalk free topology transceivers to communicate between panels and to the host computer. The network is designed to accommodate bus, star, or loop topologies or any combination of these topologies. A single twisted pair wire is all that’s needed. LonTalk is very robust and will operate on many different types of cable.

Performance will vary with cable type. The transmission specification depends on such factors as resistance, mutual capacitance, and the velocity of propagation. The system performance on the cables listed in the table below have been tested and documented.

Cable Type	Wire Dia./AWG	R loop Ohm/km	C NF/km	Vprop % of C
Belden 85102, single twisted pair, stranded 19/29, Unshielded, 150 degree C	1.3mm/16	28	56	62
Belden 8471, single twisted pair, stranded 19/29, Unshielded, 60 degree C	1.3mm/16	28	72	55
Level IV 22AWG, twisted pair, typically solid & Unshielded	0.65mm/22	106	49	67
JY (St) Y 2x2x0.8, 4-wire helical twist, solid, shielded	0.8mm/20.4	73	98	41

It should be noted that shielded data cable is not required. If shielded data cable is to be used, the shield wire should only be terminated at one end of each wire segment. If shielded cable is used the distance limitation is reduced by approximately 50%.

Field Device Cable Specifications

Device Type	Cable Type	Max Length
Inputs	22/2 stranded	1000’
Glass Breaks, PIR, REX	22/4 stranded	1000’
MagLock	18/2 stranded	1000’
Electric Strikes	18/2 stranded	1000’
Panel power	18/2 stranded	100’

MASC Configuration Options

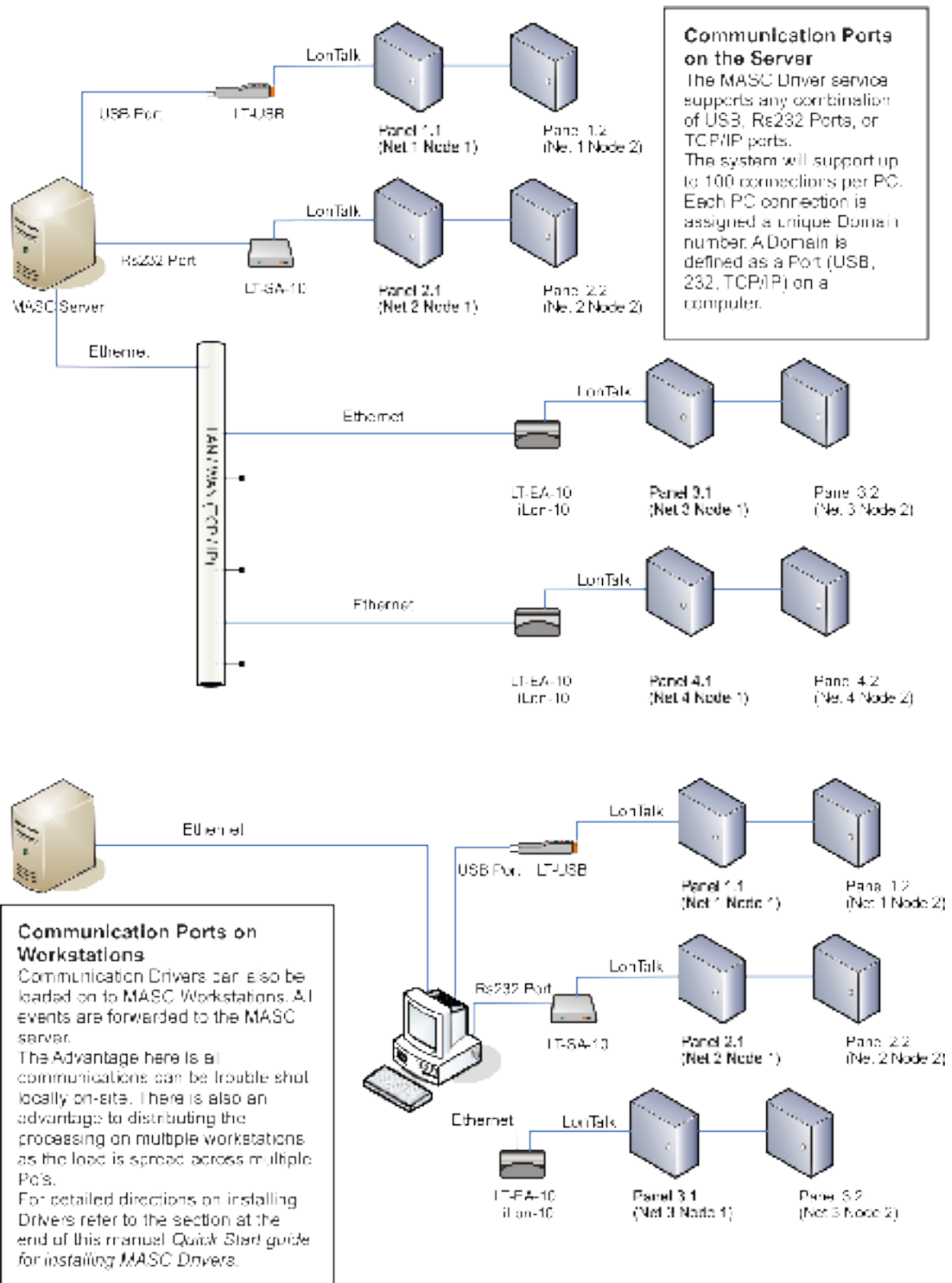

Wiring Topologies

Free Topologies

When using free topology cabling, the only criteria that matters is the total length of cable. Star and loop configurations are both supported. As the chart below illustrates, Low impedance Cat V cable allows for a total of 400 meters of cable in any one segment. Up to 63 devices can exist in any one segment. If you need to go farther you can add a repeater which separates your wiring into two segments. Free Topology is terminated with a single 52 ohm resistor preferably located towards the center of the segment. Loop topology has the advantage of redundancy. If for any reason that the loop gets cut, the network will not stop functioning unless the network has a direct short at the point where damaged. Free topology is very forgiving and may appear to work just fine without the termination resistor, but it still important to place this resistor on the trunk-line especially on very short or very long distances to ensure good data flow and avoid network collisions. The Echelon communications line is not polarity sensitive. Several examples are provided here.

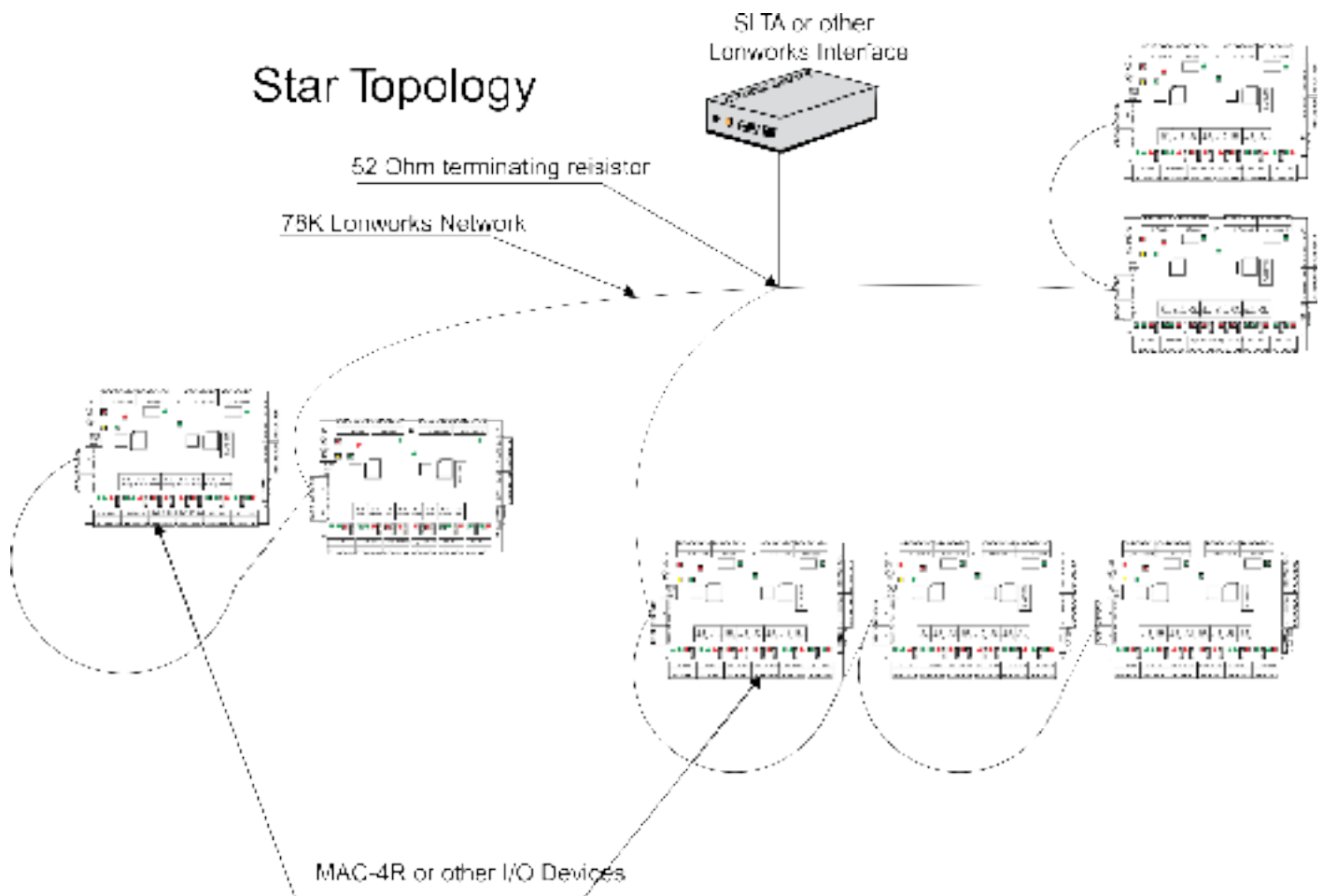

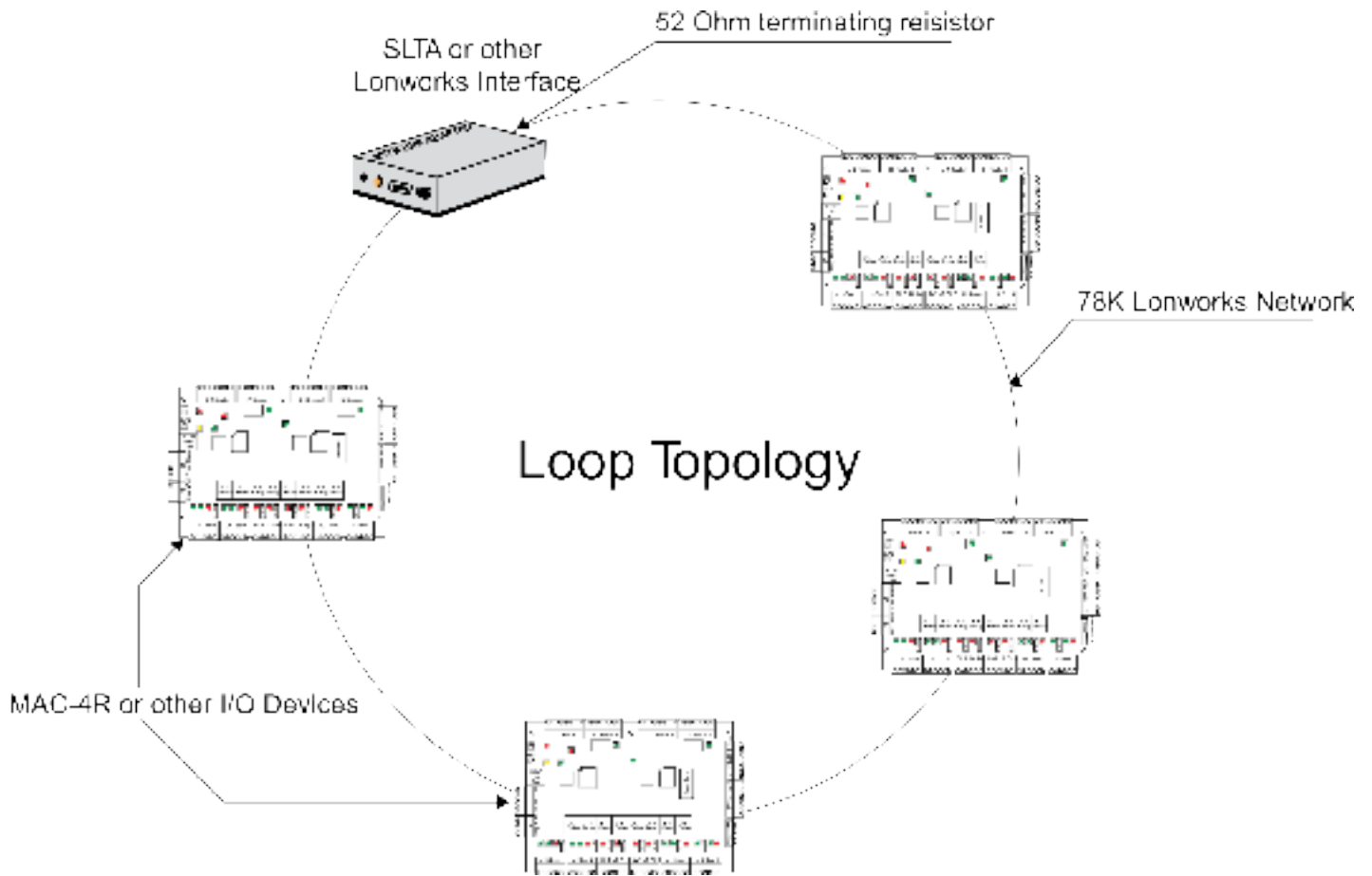

Whenever you wire the controllers in a loop it is very important to observe polarity. Host Net A must be attached to A and Host Net B must be attached to B. This includes proper polarity on the network adapter as well.

Free Topology Specifications

	Maximum distance between any two nodes.	Maximum total wire length per segment.
Belden 85102	500 meters	500 meters
Belden 8471	400 meters	500 meters
Level V,22AWG	400 meters	500 meters
JY (St) Y 2x2x0.8	320 meters	500 meters

Bus Topologies

If a more robust long distance network is required a double terminated Bus network is recommended. With a 16-2 twisted pair (Belden 85102 or equivalent) you could extend your network up to 2700 meters or 8800 ft. A 105 ohm resistor is placed at the extreme physical end of each end of the network.

Doubly Terminated Buss Topology

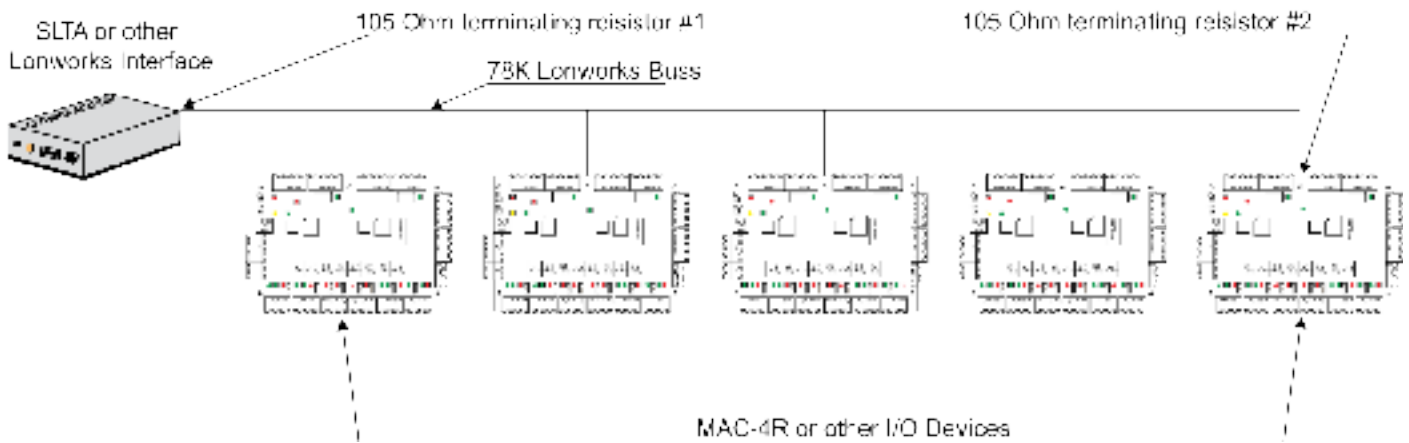

Single Terminated Buss Topology

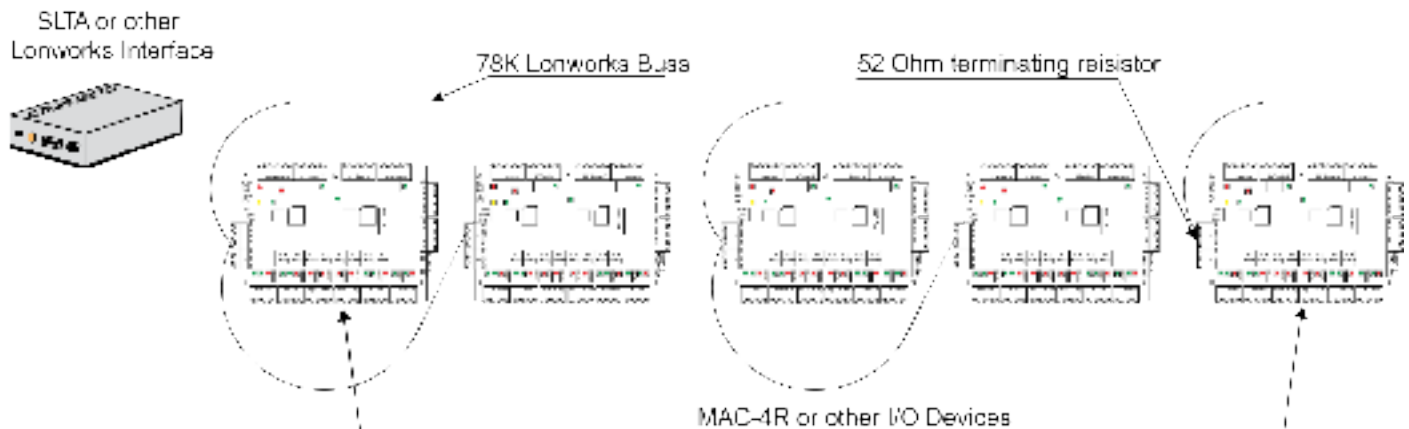

In a single terminated buss topology all the same rules as free topology apply.

Buss Topology Important Detail

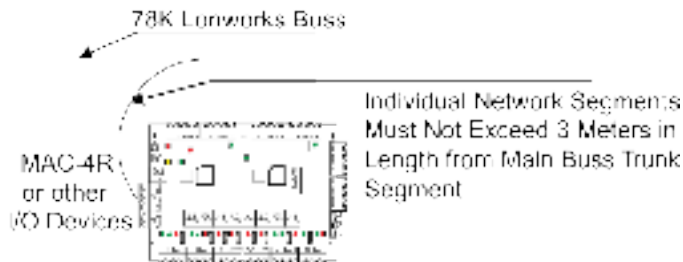

Buss Rules and Limitations

In a doubly terminated bus topology, two (105 ohm resistors) terminations are required, one at each end of the bus. Control Panels connected to the bus must not have more than a 3-meter stub length. The Lon-Talk Serial adapter is just another node on the network so it can be located anywhere on the bus. Doubly terminated bus configurations do not have a maximum node-to-node distance, so you could have one controller 1,000 meters away from 10 controllers in another area of the building. The same rules apply to bus terminations as there are only 63 devices allowed per segment. At this time the cable is fully loaded, to expand it a repeater must be added.

Double Terminated Bus Specifications

	Maximum bus length for segments with Free topology transceivers wired as double terminated bus.
Belden 85102	2700 meters
Belden 8471	2700 meters
Level V,22AWG	1400 meters
JY (St) Y 2x2x0.8	900 meters

SLTA-10

The Serial Lon-Talk Adapter connects to the server PC via an RS-232 connection. Distance limitations are 50' maximum with low cap cable. All communications are verified between the controllers and computer.

SLTA-10 typical dipswitch settings

Switch Settings		
1	Buffered Link/ Alert Ack. protocol	Off
2	Remote Host/ Local Host	Off
3	Net disables after reset/ Net Always Enabled	Off
4	NSI Firmware/ SLTAFirmware	Off
5	Autobaud Enable/ Autobaud disabled	Off
6	Baud rate 19,200	On
7	Baud rate 9,600	Off
8	Baud rate 2,400	Off

SLTA-10 Side View Switch Settings

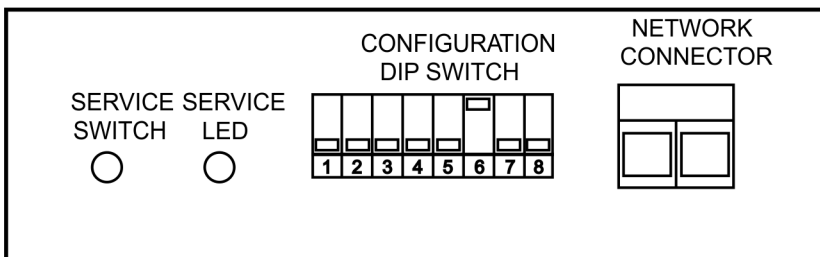

Connecting Power

The ENC-RM rack requires a regulated UL approved 12VDC power supply with enough amperage to adequately power the control panels in the rack. A good rule to follow is to provide 1/2 amps per controller. The adapter with the highest draw is the MLC-16R, if all the relays are ON the controller can draw up to 590ma. A 4 amp power source could power one rack; a 6.5 amp power supply could very well power two racks.

The power connect is connected to J1. the 24V power connection is running through the back plane and is currently reserved for future use. Connecting power to the 24 volt connecting will not harm 12 volt controllers as the power bus is isolated from one another.

J2 Terminals 1 and 2 are for the host data connection, 78Kbps communications. Panel Ground is connected to J2 pin 6. This ground should not be an electrical circuit ground. It should be connection to a ground rod, water pipe or integral building steel.

If the BP-7 is near the center or at the extreme physical end of your network and you need to do a network termination at that point. We provide you with a set of dip switches to terminate your network. The set-up of these switches are as follows.

	SW1	SW2	SW3	SW4
No Termination	Off	Off	Off	Off
Single Termination	Off	Off	On	On
Double Termination	On	On	Off	Off

Single Termination provides a single 52 Ohm termination for free topology termination as near as possible to the center of network.

Double Termination provides a single 105 Ohm termination for Double Buss topology at the extreme physical end of a network segment.

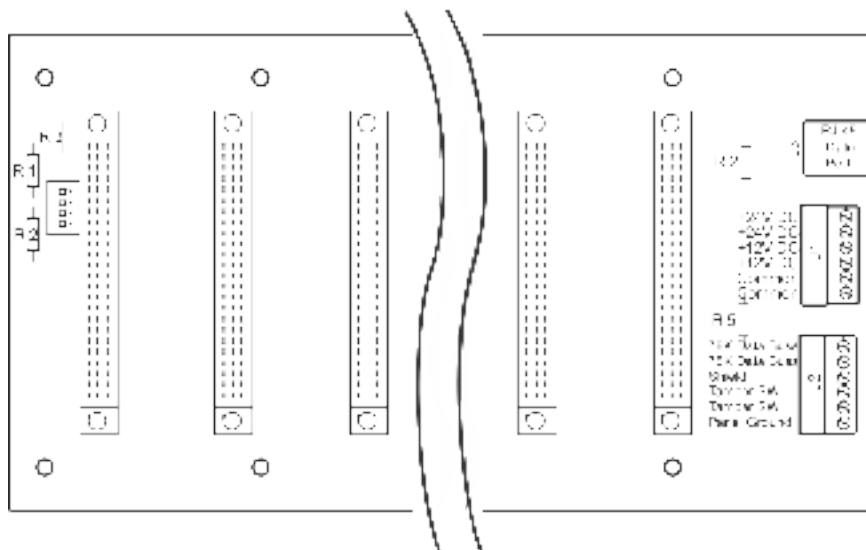

Panel Grounding

The ENC-RM Rack should be grounded by connecting an earth ground to J2 Terminal 6. **The installer should always insure the enclosure box is earth grounded at the nearest building ground point.** Earth grounding the enclosure provides a discharge path for power surges and ESD. **An electrical circuit ground is not an acceptable ground path. The ground should be to a ground rod, building steel or other true ground source.** The ground wire should be 8-10AWG wire and be kept as short as possible.

System Battery

The ENC-RM Rack does not have an internal system battery. The user supplied power supply should include battery backup where this feature is required. Insure the backup batteries are sized to provide adequate power to the rack during main power failures.

Panel Tamper Switch

The ENC-RM Rack enclosure includes a tamper switch and terminates on connector J2 Terminals 4 and 5. The switch should be wired so that when the enclosure door is closed shut, the switch is then in the closed contact position. The switch is wired as normally open.

RAM Battery

The RAM battery provides memory backup in the event all system power and the system battery fail. **To Enable the memory, install the 3.6v Lithium Battery in it's socket on the MPU-24 Communications Processor Board.** See I/O Board requirements later in this manual.

Relay Outputs

The MLC16R-RM Output Card has 16-high level control relays. Each relay is rated for 6 amps @ 300 volts AC with Form "C" type contacts. Each relay has its common pole protected by 5 amp @ 125 volts 2AG Type user replaceable fuse. Relay contacts are electrically isolated from other circuits.

MLC-32i-RM Input Card

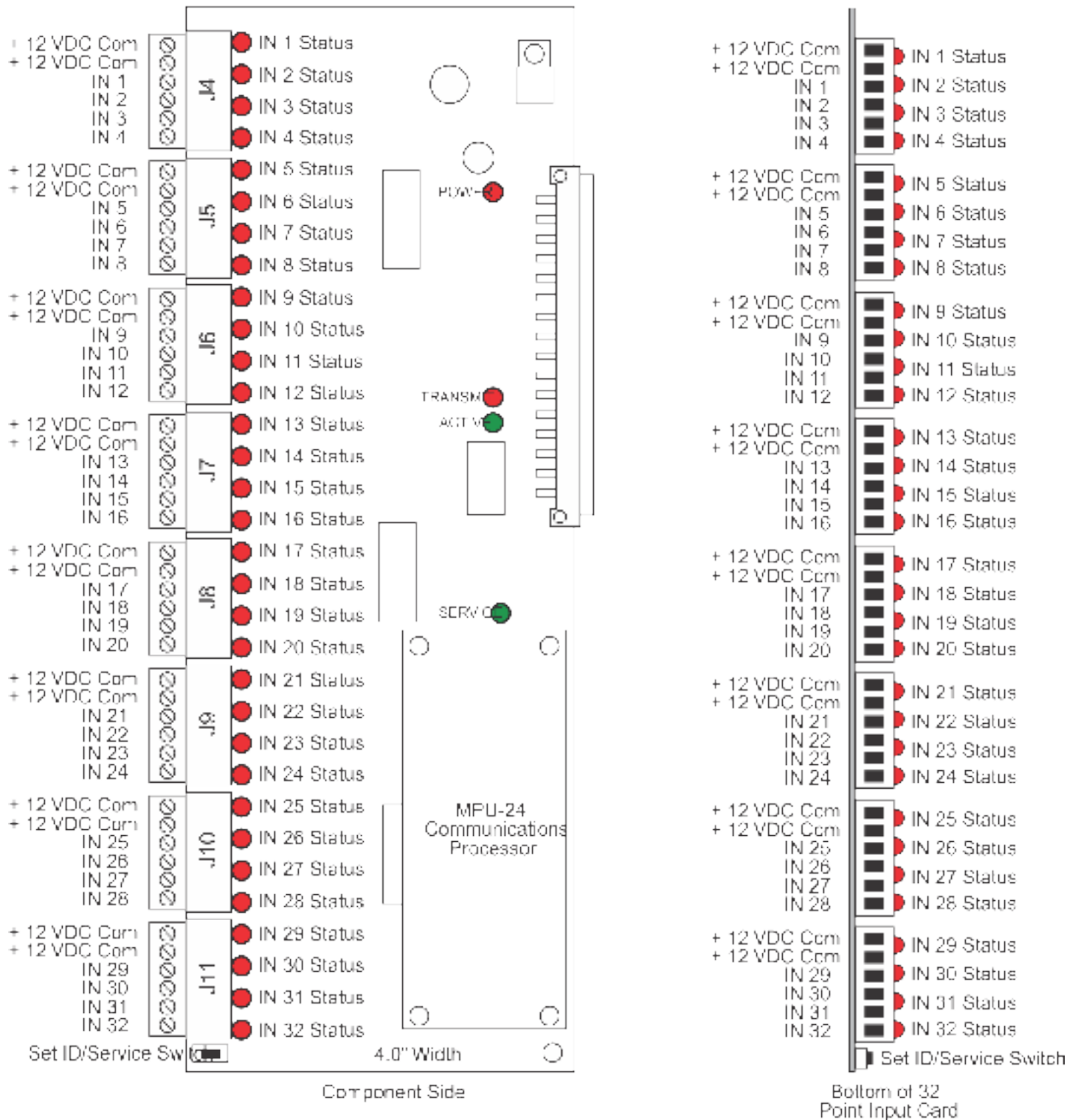

Input point status monitoring card

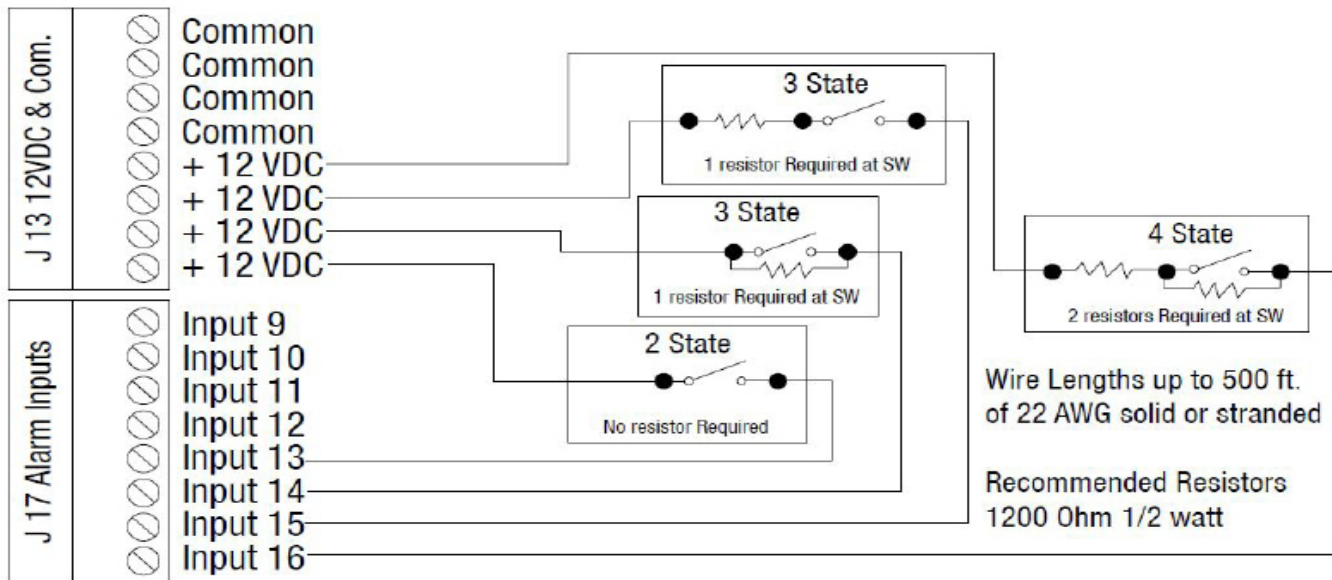

- When the Logic Controller unit first powers up the (top) Red LED will light up showing you have power.
- The (middle) Red LED is the communications LED and should flash off when transmitting.
- The (middle) Green LED should come on after about 10 seconds. It will only display after a valid RAM pass inspection.
- The (Lower) Green LED is the Server light and should not be on. If it's On check the daughter card connections as the processor was not able to boot properly

MLC-16R-RM Output Card

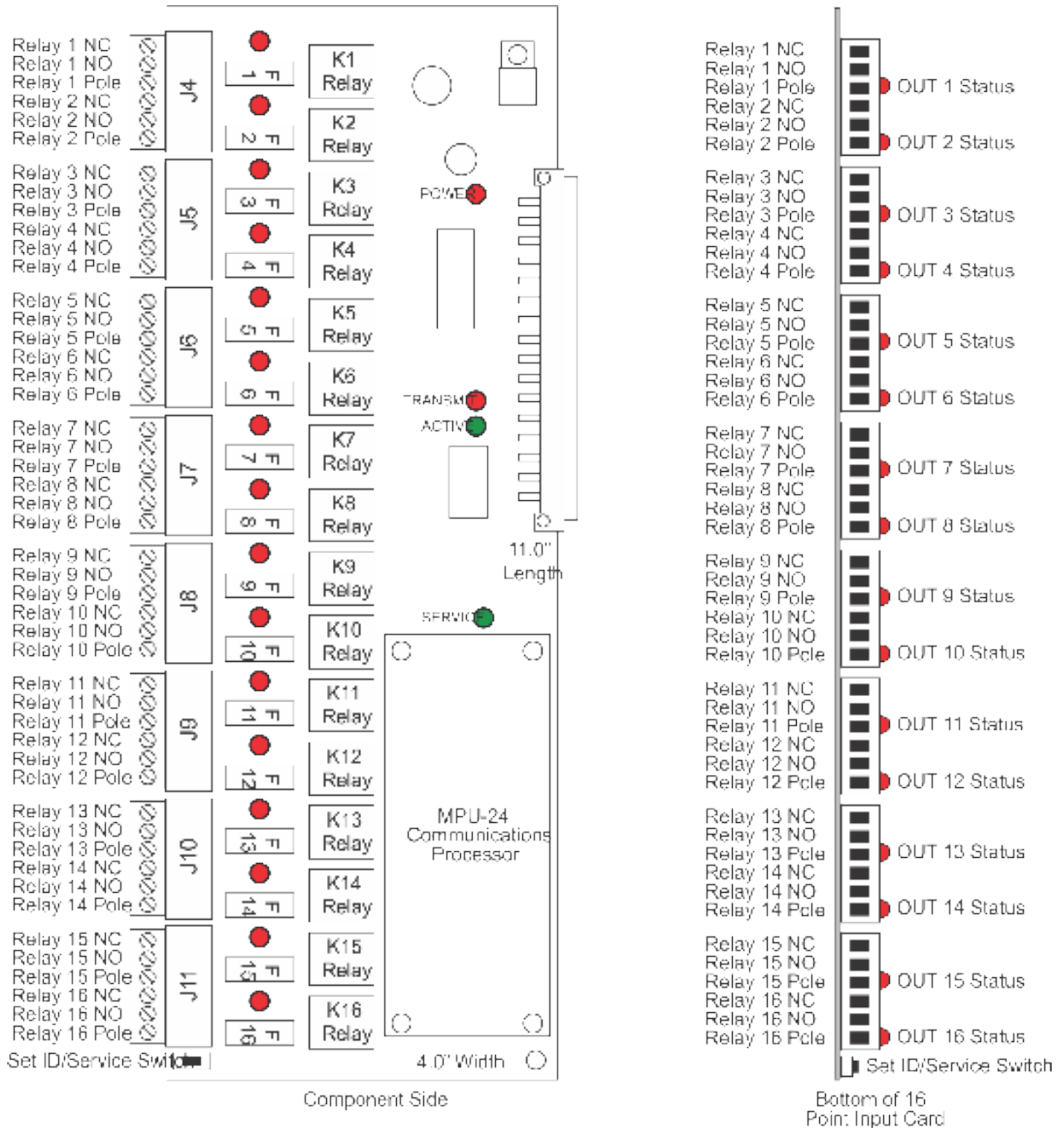

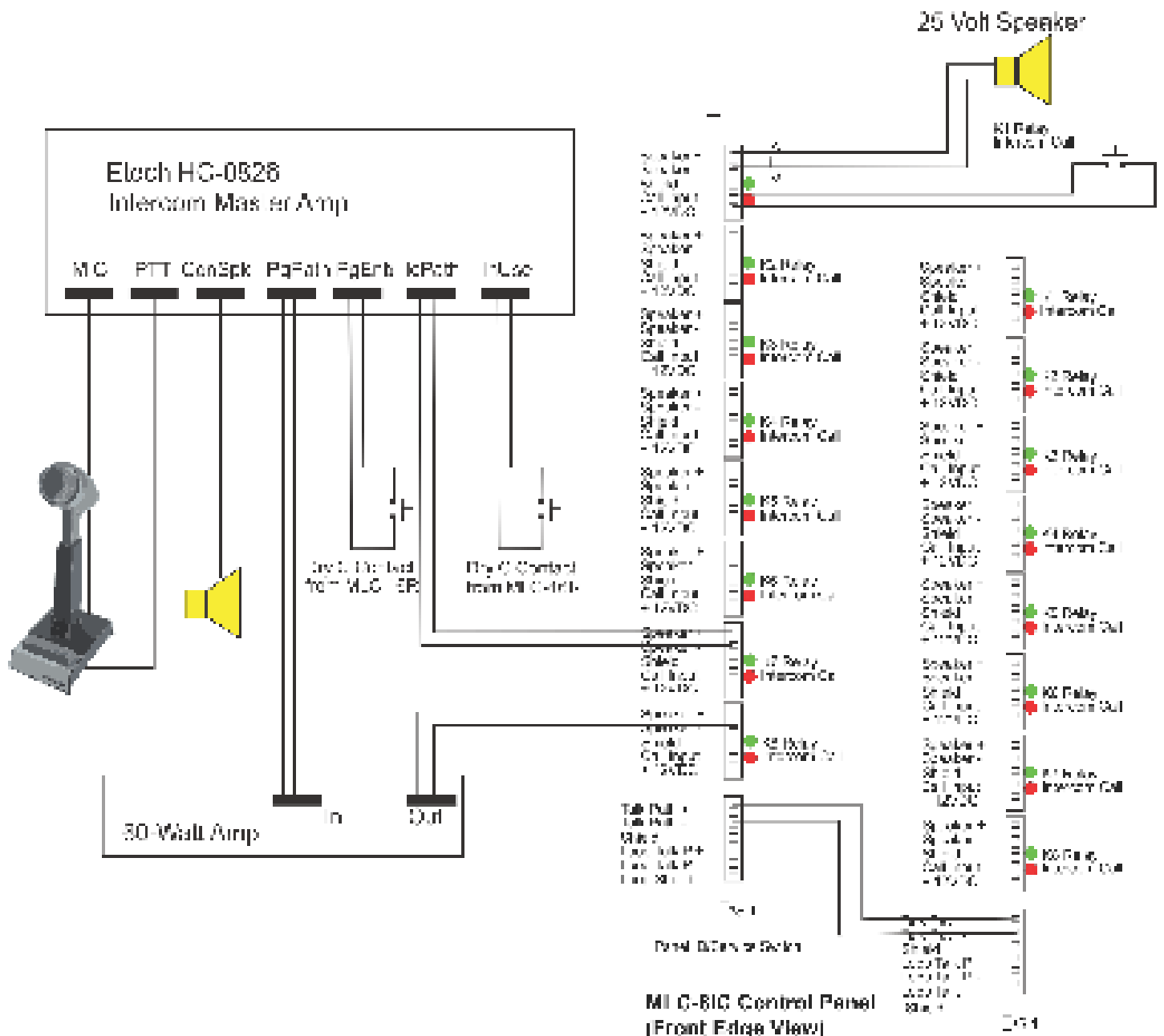

Programming

Set Possible Relays need to be energized to sound the Talk-Fair.

The "InUse" relay connects the master console. Without this relay there would probably be a continuous buzz as the electronics would be active without any field connection.

Two relays are required for every Master Console as the Pg Path and Paging path cannot be connected at the same time or you could blow the amp. Energize either the Pg Path or Page Path and Pg Path to press the Master on the bus.

Open the side on(paging speakers) needed for the call.

MLC-81C Control Panel (Front Edge View)

MPU-24 I/O Processor Board

The MPU-24 processor board contains all memory and processing controls. This board is used on the MLC-32I, MLC-8IC and MLC16R-RM I/O cards. DO NOT MIX the processor boards between input and output cards. While the processor boards are the same, the program code for an input card is different than that of an output card. If they are swapped (processor from input used on an output card or vice versa) no damage to the boards or cards will result, but they will not function as intended. In order to retain all transaction information 3.6v lithium battery must be installed where shown in the diagram below. The battery snaps into place. Install with the polarity as shown.

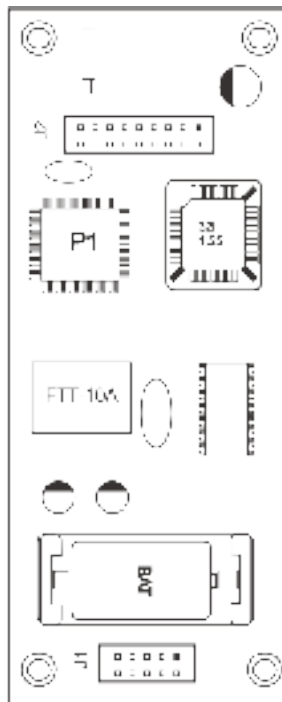

MLC-32I

I/O Card Specifications

32 analog 10 bit resolution points.

MLC-32I-RM	Typical	Minimum	Maximum	All Points Off	One Point On	All Points On	Remarks
Operating Voltage	12 VDC	11.5 VDC	15 VDC				DO NOT exceed maximum operating voltage.
Operating Current Base Panel		60 ma	456 ma	60 ma			Measured at typical operating voltage. At maximum voltage maximum current =1.20 amps
Input Voltage	0-12 VDC	.012 mVDC	15 VDC				DO NOT exceed maximum input voltage.
Input Current	15 ma	15 uA	37.5 ma	0 ma	12 ma	396 ma	Includes Tamper Switch input through buss. Tamper switch is point #33 of I/O object.
Output Voltage	12	11.5 VDC	15 VDC				Input connector commons.
Output Current		0 ma	1.2 amps				DO NOT exceed maximum.
Data Communications	78 KB	78 KB	78 KB				Standard operation is 78 KB. Special router will allow up to 1.25 MB operation internal to rack.
Memory Backup	18 months	12 months	24 months				10 year shelf life maximum. Memory backup duration is dependent on RAM version used.
Operating Temp	10-40 C	0 C	+50 C				
Operating Relative Humidity	40%	0	95%				Non-condensing
Field Wire Termination	18 AWG	24 AWG	14 AWG				Solid or stranded. Stranded is recommended.
Field Wire Terminal Voltage	0-30 VDC	0 VDC	125 VAC				Maximum terminal rated voltage 125 VAC.
Field Wire Terminal Current	0-5 amps	0 amps	5 amps				Maximum terminal rated current 5 amperes.

MLC-16R

I/O Card Specifications

Relay output control card. 16 form "C" type contacts.

MLC-16R-RM	Typical	Minimum	Maximum	All Points Off	One Point On	All Points On	Remarks
Operating Voltage	12 VDC	11.5 VDC	15 VDC				DO NOT exceed maximum operating voltage.
Operating Current Base Panel		50 ma	640 ma	60 ma			Measured at typical operating voltage. At maximum voltage maximum current =1.20 amps
Input Voltage							Dry Contact Switching Only.
Input Current							Dry Contact Switching Only.
Output Voltage							Dry Contact Switching Only.
Output Current		37 ma	41 ma	0 ma	37 ma	590 ma	Dry Contact Switching Only.
Data Communications	78 KB	78 KB	78 KB				Standard operation is 78 KB.
Memory Backup VIA NC-PU24	18 months	12 months	24 months				10 year shelf life maximum. Memory backup duration is dependent on RAM version used.
Operating Temp	10-40 C	0 C	+50 C				
Operating Relative Humidity	40%	0	95%				Non-condensing
Field Wire Termination	18 AWG	24 AWG	14 AWG				Solid or stranded. Stranded is recommended.
Field Wire Terminal Voltage	0-30 VDC	0 VDC	125 VAC				Maximum terminal rated voltage 125 VAC.
Field Wire Terminal Current	0-5 amps	0 amps	5 amps				Maximum terminal rated current 5 amperes.
Load Voltage	12-30 VDC	0 Volts	125 VAC				Voltage across load switching relay contacts.
15 VDC				Voltage across load switching relay contact.			Current through load switching relay contacts.
Load Current	250 ma	5 ma	5 amps				Current through load switching relay contacts.
Load Fusing	5 amp	½ amp	5 amp				Standard is 5 amp medium duty relay.

MLC-8IC

I/O Card Specifications

8 Station Audio card. 8 form "C" type contacts.

MLC-8IC-RM	Typical	Minimum	Maximum	All Points Off	One Point On	All Points On	Remarks
Operating Voltage	12 VDC	11.5 VDC	15 VDC				DO NOT exceed maximum operating voltage.
Operating Current		60 ma	296 ma	60 ma			Measured at typical operating voltage. At maximum voltage maximum current =1.25 amps
Input Voltage	0-12 VDC	0.012 mVDC	15 VDC				Dry Contact Switching Only.
Input Current	15 ma	15 uA	37.5 ma	0 ma	12 ma	96 ma	Dry Contact Switching Only.
Output Voltage							Dry Contact Switching Only.
Output Current		16 ma	18 ma	0 ma	17 ma	140 ma	Dry Contact Switching Only.
Data Communications	78 KB	78 KB	78 KB				Standard operation is 78 KB. Special router will allow up to 1.25 MB operation internal to rack.
Memory Backup VIA NC-PU24	18 months	12 months	24 months				10 year shelf life maximum. Memory backup duration is dependent on RAM version used.
Operating Temp	10-40 C	0 C	+50 C				
Operating Relative Humidity	40%	0	95%				Non-condensing
Field Wire Termination	18 AWG	24 AWG	14 AWG				Solid or stranded. Stranded is recommended.
Field Wire Terminal Voltage	0-30 VDC	0 VDC	125 VAC				Maximum terminal rated voltage 125 VAC.
Field Wire Terminal Current	0-5 amps	0 amps	2 amps				Maximum terminal rated current 2 amperes.
Load Voltage	25-70 V	0 Volts	125 V				Voltage across load switching relay contacts
Load Switching	1-10 W	1/8 w	60 W				Switching power of Relays.
Load Current	250 ma	5 ma	2 amps				Current through load switching relay contacts.
Load Fusing	250 ma	½ amp	1.2 amps				Current through fusing circuit.

MPU-24

I/O Card Processor Memory Board Specifications

Application and communications processor board. Plugs onto MLC32I input card and MLC16R relay output control card. Provides transaction storage time stamped to the second.

MPU-24	Typical	Minimum	Maximum	All Points Off	One Point On	All Points On	Remarks
Operating Voltage	5 VDC	4.75 VDC	7 VDC				DO NOT exceed maximum operating voltage.
Operating Current	40 ma	20 ma	100 ma	20 ma	20.5 ma	66 ma	Measured at typical operating voltage.
Oscillator Frequency	10 mhz	10 mhz	10 mhz				Processor speed.
Flash Memory	32 KBs x 8 bits	32 KBs x 8 bits	32 KBs x 8 bits				System image and application program stored. 90 ns Atmel AT29C256
RAM/SRAM Memory	24 KBs x 8 bits	24 KBs x 8 bits	24 KBs x 8 bits				32 KBs x 8 SRAM 15 ns low data retention current version.
Real Time Clock							Accuracy is +/- 2 minutes per month. Resolution is 1 second. Y2K compliant.
Data Communication	78 KB	78 KB	78 KB				Standard operation is 78 KB. Special router will allow up to 1.25 MB operation internal to rack.
Memory and RTC Backup	18 months	12 months	24 months				10 year shelf life maximum. Memory backup duration is dependent on RAM version used.
Operating Temp	10-40 C	0 C	+50 C				
Operating Relative Humidity	40%	0	95%				Non-condensing

MLC-16R, 32I, 8-IC Troubleshooting Guide

All 3 of these products have been designed with the same characteristics, so the troubleshooting procedures follow the same sequence. This troubleshooting guide has been divided into 5 sections.

Sections

1. Power Problems
2. No Communications
3. Basic Processor Operation
4. Input Problems
5. Output Problems

Section 1 Power Problems

Is Red PWR led on?	<ul style="list-style-type: none"> • On 32i check (D1), 16R check (D2), 8IC check (D2) • Check incoming voltage on +12vdc and Com. Power should be minimum of 12 v. and not over 18vdc • Move adapter to another slot. • Dead short in field, the positive 12v from control panel might have a dead short to earth ground somewhere. Disconnect all terminal blocks and cycle power. Did PWR LED come on? If not replace MLC-xx-PCB. If yes, continue
Check Ground?	<ul style="list-style-type: none"> • Take a VOM (set on continuity) and check Panel Gnd terminal to Earth or structural ground. Meter should show continuity.

Section 2 No Communications

Is Red Xmit led on or flashing?	<ul style="list-style-type: none"> • On 32i check (D3), 16R check (D27), 8IC check (D15) • It should be, If not, could have processor problem, go to Section 3
Is Driver Service Loaded?	<ul style="list-style-type: none"> • No, Load and configure Driver Service

<p>Is Driver status Double Green?</p>	<ul style="list-style-type: none"> • Open the Driver service on the Host Computer by right clicking on the Double Green box in the system tray, Select Open. <p>Top icon represents Host Connection, Lower box represents Network connection.</p> <ul style="list-style-type: none"> • Green, connection established. • Blue represents Off-Line, Right click and turn it On-Line • Red, Top -Panel on Domain not found in Host computers. The driver service cannot find a panel in the DB for the Domain set in Driver Service. • Red, Bottom – PC Port for Echelon adapter not found, RS232, USB port, or IP port does not exist on this computer. • Yellow, bottom – Timeout, Panel ID might not be set. • Driver must show Green on top and on either yellow or green on bottom to continue.
<p>Is MAC-4R Address Set?</p>	<ul style="list-style-type: none"> • Test connectivity by opening MLC-xx RTU and hitting the service pin of the control panel. If cable and driver are working a message should pop up stating that the System has just received a new Neural ID, Do wish to use this ID for this control panel? Did the message come up, Yes continue. If no, check cable • Accept the new Neural ID, Hit Apply, and Load Device Address. To test send a “Clear All” you should receive one events back, P1 Ram Pass, If you did not receive this continue • Perhaps the Hardware Domain is set to the wrong address. Use NodeUtil to view the panel address and domain.
<p>View Driver Messages</p>	<ul style="list-style-type: none"> • While downloading Settings to a control panel open up the Driver, Messages display, you should be averaging 6 commands per second with an ACK after each message. If not you have a wiring problem.

Section 3 Basic Processor Operation

Is Grn Run LED on?	<ul style="list-style-type: none"> If the firmware loaded properly the Run LED should be on. It normally takes about 3-5 seconds to turn on from power up. On 32i check (D5), 16R check (D3), 8IC check (D3)
Is Grn Service LED on?	<ul style="list-style-type: none"> On 32i check (D4), 16R check (D23), 8IC check (D19). If yes, The control panel has lost it's firmware, Send the control panel back to factory. If no Continue.
Send "Clear All" to Control Panel	<ul style="list-style-type: none"> Send a "Clear All" you should receive one event back, P1 Ram Pas. If OK Continue.
Send Setting to Control Panel	<ul style="list-style-type: none"> The Setting tab includes all basic operation of MLC-xx

Section 4 Input Problems

No Input Events	<p>Possible Causes</p> <ul style="list-style-type: none"> Run though Check Communications above Settings were never downloaded into Control Panel Input Properties Screen, Operation Tab, RTU transmit must be selected. Set to wrong type of input; 2-state, 3-state, 4-State etc.. Check Led for input, Led needs to follow state, Led On is closed, Led goes off is Open. Look for A/D Fail Alarm, if yes your Analog to digital chip has been blown, replace MLC-xx
Input Reversed	<p>Input reports as Open when Closed and Closed when Open</p> <ul style="list-style-type: none"> Goto Inputs Setting Tab and Select the Invert Box
Input Alarm when Closed	<p>Input goes into Alarm when the door closes</p> <ul style="list-style-type: none"> Goto Inputs Setting Tab and Select the Invert Box

Section 5 Output Problems

Output not Working	<p>Possible Causes</p> <ul style="list-style-type: none">• Run though Check Communications above• Settings were never downloaded into Control Panel• Does LED go on, go to next. If No, go to Run Mode, show Tree, Allow Point Settings. You may have to edit user and set this option on. In Run mode, Expand RTU Outputs and Force Output High, LED should go On, If software shows it's forced on but the LED is not on, replace MLC-xx
Led on but Device not Tripped	<p>Possible Causes</p> <ul style="list-style-type: none">• Check Fuse with VOM• Disconnect wiring from relay and check continuity on N/C side with relay off, you should have connectivity. If not replace MAC-4R• Check continuity on N/O side with relay on, you should have connectivity. . If not replace MLC-xx

Quick Start Guide for Installing MASC

Installing and Configuring the MASC Server Software

1. Install the MASC Software on the Server. Make sure to select the following options:
 - a. Install as Server
 - b. Add Drivers, Select MAC-4R Series
 - c. Projects to Copy, No
2. The first time you load MASC the software will ask some configuration questions. Execute the MASC desktop icon from the desktop.
 - a. MASC Program Loader, This is asking which modules to run. Keep Server, DriverService and Workstation and hit OK.
 - b. There are (3) screens upon each other. Move the screens around so you can get to the Server Registration Screen. Keep Defaults and Hit OK.
 - c. The Server License screen will pop-up. It shows the MAC address of the last network adapter installed on the server. To register the software, do a Alt-Print Screen and paste it in MS Paint. Save it as a .jpeg and email it to OSSI to get your License Number. In the meantime, hit Cancel and the program will still load and be fully functional for two hours. You can program your system. If you run out of time exit all three modules of MASC; re-start it and you'll have another 2 hours.
 - d. On the MASC Workstation Registration Screen, Hit OK to accept all defaults. The User name is master and the password is m. You are now ready to program your system. Before you can actually turn your driver communications ON you need to have some control panels in your database.

Quick Start Guide for Installing MAC-4R Drivers

If the install requires the use of the Echelon USB adapter (LT-USB), or iLon-10 adapter (LT-EA-10) then follow the next few steps to install the hardware drivers before you attempt to install the MASC MAC-4R driver. These two adapters require the proper Open LDV hardware drivers before the MASC Driver can be installed.

SLTA-10	RS232 Serial Port
LT-USB	Open LDV Port
LT-iLon-10	Open LDV Port
Lantronix to SLTA	TCP/IP Port

Installing Driver for Echelon LT-USB Adapter

1. Insert the CD that came with you USB adapter leaving the USB adapter unplugged. This will install the hardware files required to support the USB adapter.
2. Upgrade to Open LDV version 3.4. Go to the MASC CD and open the OpenLDV subdirectory. Execute the OpenLDV340exe file and follow the prompts to install Open LDV.
3. Now plug the LT-USB adapter into an open USB port. If this is the first USB adapter this computer has loaded it will be assigned to port "Lon1". The PC now has all the information to properly load the new MASC drivers. If there are any problems with this go to Start, Control Panel, LonWorks Interfaces. Under the USB tab (with the USB adapter plugged in) you should have a network port called LON1.

Installing Hardware Driver for iLon-10 (LT-EA-10) Adapter

1. Install and insert the CD that came with the iLon-10 adapter. Execute the setup.exe file, follow the prompts and the CD will install the hardware drivers required to support the devices.
2. Upgrade to Open LDV version 3.4. Go to the MASC CD and open the OpenLDV subdirectory. Execute the OpenLDV340 exe file and follow the prompts to install Open LDV.
3. The PC will need to be set to a compatible IP address to 192.168.1.xxx, Subnet 255.255.255.0.
4. Now plug in the LT-EA-10 (iLon-10) adapter into a network port. Using Windows Internet Explorer set the iLon's IP address of the iLon-10 to an IP address compatible with the network you need to run on. It needs to be something other than the default address of 192.168.1.222
 - a. You connect to the device in Explorer with <http://192.168.1.222/config>
 - b. User name ilon, Password ilon
 - c. If any free software display, make sure to allow connections for that device.
 - d. Change the IP address in the IP address field
 - e. Set the Subnet Mask to something compatible with the network it will run on. Most networks are set at 255.255.255.0
 - f. Scroll down and click Submit
 - g. To verify the changes have been done properly you can click on the provided link to connect to the adapter again or go to the next step.

5. Add the device as a piece a hardware in Lonworks Interfaces.
 - a. Go to Windows Control Panel, Lonworks Interfaces, Remote Network Interface (RNI) tab and add your hardware. This is where the driver will find the IP address of the network interface.
 - b. Highlight "Default" on the base tree, Click on Add button.
 - c. Specify a name for the device. This name will automatically be given a prefix you will not be able to change. You could name the device after the last number on the IP address or perhaps the building name. For example if you name it 111, when you add an OpenLVD driver in MASC you would select "x.default.111" from the picklist.
 - d. Network Manager select "Other".
 - e. Enter the new IP address of the iLon-10.
 - f. Click Finish.
 - g. Highlight the XDefault name and click "TEST" Function.
 - h. Click Start. If everything worked the last line of the procedure will provide Success.

Adding a MAC-4R Driver

1. To add a MAC-4R driver, right click on the double green set of boxes in the system tray. Select Open. This screen displays all the drivers installed for the system. If you have not installed any drivers, this screen will be blank.
 - a. On the MASC Driver Configuration Screen, Select Add, when prompted, select MAC-4R series. Select the proper Communications Type: RS232, IP, or Open LDV. If you have a Echelon USB or iLon-10 adapter select Open LDV.
 - b. A configurations screen will appear. Select the proper port. If adding a Serial port, go to the 232 tab and select the proper com port. If adding an OpenLDV device, go to the OpenLVD tab and select the proper OpenLDV port. Lon1, Lon2, X.Default.xxx.
 - c. Go to the Driver tab and provide a unique domain number. The default is 40. This number can be any number between 1-255. The Domain number is cross referenced to the Domain field on the MAC-4R RTU screen.
 - d. Driver Tab, Make sure the Net feld matched the Echelon subnet of the MAC-4R panels you wish to communicate to.
 - e. Accept the default entries for the rest by hitting OK.
 - f. Upon creating a new port, the system adds the new port in the off-line state (Blue Icons). If you're ready to talk with these controllers, right click on the driver and select on-Line. If you do not have any controllers in your database for this port leave the driver port off-line until after you add controllers and are ready to talk to them.

Add Control Panels

1. Add the control panels into the database by right clicking on a Site and selecting “Add Node”.
2. Open the new controller and make sure the Domain and Net numbers match the port the control panel is assigned to.
3. Name the Controller; we suggest using the building name followed by the Net, Node address. Pederson 2-1 etc. Hit Apply.
4. Take the virtual flag off, Hit apply. The panel name will show up in the Alarm que as Off-Line as the Server is now trying to communicate with the controller.

Turn Driver On-Line

1. After adding the Controllers to the database and communication wires are installed, you’ll have to open the DriverConfiguration Screen to turn the port on-line.
2. Right click on the double green set of boxes in the system tray. Select Open. This screen displays all the drivers installed for the system.
3. Right click on the double blue squares for the port in question and select On-Line.
4. If communications are established to the server the top icon will be green. The lower icon shows the status for connecting to the port. If it turns green, you are talking to the port. If it turns yellow, the system is timing out, it found the port but cannot find the Echelon adapter. If it turns red the system cannot connect to the port.

Set the Address of the Controller

1. By default a control panel is shipped at address (1.120). When you add a new controller to the database the controllers start at Net/Node address 1.1. and move up from there. To set a panels address the MASC software needs the unique neural ID of the panel you are trying to set.
 - a. Open the RTU screen of the panel you wish to set and Hit the service Pin.
 - b. The system will display a popup window saying, “A new neural ID has been received, do you wish to use it”. Select Yes.
 - c. Hit apply to save the changes.
 - d. Hit Load Device Address.
 - e. Use the “Set Date and Time” to test communications. If all worked properly you should not see a panel Off-Line alarm in the Alarm Que.
 - f. Download the Settings and cards to the Control Panel.